



OBSESSED WITH HIGH RESOLUTION

KEF R&D

R Series 2018

Contents

Introduction	5
Philosophy	5
Objectives	5
The cabinet	6
Visual design	6
Minimising panel sound radiation	6
Directivity and diffraction	8
Ports	9
Resonance inside the cabinet	10
Organ pipe resonances	10
Turbulence	10
Drive units (Drivers)	10
Bass drivers	10
Diaphragm	11
Magnet system	11
Spider (Damper)	12
Uni-Q array	12
Filling in the gaps	13
Midrange	13
Cone and surround	13
Magnet system	14
Tweeter	14
Diaphragm assembly	14
Tangerine waveguide	15
Rear loading	15
Crossovers	16
Model Range	18
R3	18
R5	19
R7	20
R11	21
R2c	22
R8a	23
Summary	24
Acknowledgements	24
References	24



R11 in Black Gloss finish

Introduction

It is 7 years since the first R Series products were introduced. In that time, KEF's Research and Development work has continued and its best technology has improved. The fruits of this work can be seen in the 2014 Reference Series and the Blade 2. Behind the R series 2018 are a wealth of technical updates and improvements – some trickle-down from the Reference and Blade projects and some specific to the new series. The result is a significant step up in performance and a purity of sound that's clear from the first listen.

Philosophy

"Of all art, music is the most indefinable and the most expressive, the most insubstantial and the most immediate, the most transitory and the most imperishable. Transformed to a dance of electrons along a wire, its ghost lives on. When KEF returns music to its rightful habitation, your ears and mind, they aim to do so in the most natural way they can... without drama, without exaggeration, without artifice." Raymond Cooke, KEF founder

These words were penned shortly after KEF's founding in 1961. Cooke was an avid music aficionado and his mission from the outset was to enable a wide audience to derive the same pleasure from music as he did. He sought to deliver to his customers the immersive experience of the live performance through recordings.

Cooke realised that this could only be achieved by a scientific understanding of sound and its reproduction, concentrating his efforts on loudspeakers – the last link in the recording chain and probably the most difficult in that they have to work in an unknown 3-dimensional environment. Never afraid to employ the most capable engineers and provide them with the latest and most effective tools, Cooke established a philosophy that still exists today.

KEF engineers continue to pursue this scientific endeavour, today using tools and technology that were unavailable to Cooke in those early days, never forgetting that all the science in the world is useless unless it brings better performances and greater pleasure to the user. The listening experience is still the final arbiter in deciding whether or not the science is effective, but without it progress cannot be measured and the way forward cannot be understood.

Objectives

Loudspeakers have a difficult job, not always fully appreciated. They must take a 1-dimensional signal and turn it into a 3-dimensional experience.

Stereo – the simplest common configuration – uses just two loudspeakers to create a complete sound stage for the listener. Imagine throwing a handful of gravel into a pond and trying to recreate the same ripple pattern by dropping just two pebbles into the pond spaced by about 2 metres. It can't be done and we haven't even considered height! Stereo is an illusion that, fortunately, seems to work remarkably well.

Nevertheless, there are some clearly defined attributes that separate good loudspeakers from mediocre ones:

The sound must come from the drivers and no other part of the structure. The most common form of unwanted added sound is radiation from the cabinet. The panels are relatively large in area and don't have to move much to colour the true sound.

A loudspeaker should have controlled dispersion. If the character of sound varies too much with angle, the 3-dimensional sound stage cannot be accurately formed and an acceptable listening position is very restricted. But omni-directionality is not desirable either. The acoustics of the listening room become more intrusive and can swamp any attempt to recreate the acoustic environment of the original performance.

The sound quality should be the same at all levels. The dynamic range of music (the quietest to the loudest sounds) is high and, in order to reproduce it accurately, the loudspeaker must not compress the sound nor to come to life only at relatively high levels.

There should be no harmonic or intermodulation distortion – the creation of sounds at frequencies that are not present in the original.

There should be no time or temporal distortion. This can come from resonances, where the sound hangs on at discrete frequencies, or diffraction, the re-radiation of sound at discontinuities in the structure that is delayed relative to the direct sound from the drivers.

Now, it's all very well to say that there must be none of anything, but we don't live in a perfect world. The job of the engineer is to minimise all these undesirables, ideally to a level below which they are audible. However, sometimes there are conflicting issues and, in this case, the engineer has to gauge the lesser of two evils. For example, low bass at high volumes is extremely difficult for smaller cabinets to achieve. However, smaller cabinets may be preferred for their visual quality.

This brings us to the subject of visual design. Loudspeakers must be considered a legitimate piece of furniture in the living environment. They should, in short, look good.

The cabinet

We have seen that the objectives of the cabinet are:

- To look good.
- To emanate a minimum amount of sound.
- To maintain temporal accuracy.
- To help control directivity.

There is a fifth attribute that the cabinet should also have and it is stability. The most obvious criterion is that it should not be easy to knock the loudspeaker over. Loudspeakers can be heavy and could cause discomfort or injury should they fall on anyone, especially a small child. There are furniture standards that cover this and the device should return to an upright position if it is leaned over up to 10°.

Also important to the audiophile is that the cabinet should not be allowed to rock when the drivers operate. If this happens, the bass quality is impaired. It may be described as "softening" and the effect is most noticeable on percussive bass, often referred to as "slam".

All the floor-standers in the range are equipped with spike feet that pierce through carpeting and prevent any rocking. These spike feet are fitted to outriggers that extend beyond the boundaries of the cabinet and provide the necessary static stability.

Stand-mount systems should always be mounted on a stand that affords similar stability.

Visual design

All R Series cabinets are designed to look good. They have clean lines, there is a choice of finishes – black gloss, white gloss, walnut – and the frontal aspect is slim (more of that later when we discuss temporal accuracy). The quality of fit and finish is high and, for those who prefer not to see drivers, there is the option of magnetically attached grilles.

The loudspeakers are optimised for when the grilles are not fitted and they are ideally removed for serious listening, even if they are fitted when the loudspeakers are not in use. However, the grilles are designed to have the minimum effect on sound quality.

Minimising panel sound radiation

The panels of the cabinet may be excited by two mechanisms:

- Reaction forces from the drivers – as the driver diaphragm moves back and forth there is a reaction force on the chassis (basket) that is then transmitted to the cabinet.
- Forces from pressure in the air contained inside the cabinet.

If cabinets suffer these problems, it is worth asking why we need them at all. The answer lies in the drivers themselves. They radiate the same amount of sound energy to the rear as they do to the front. Unfortunately, the rear radiation is out of phase with that from the front and, if the two are allowed to mix, they cancel each other out. The ability of sound waves to go around corners depends on the wavelength relative to the size of the object. A good analogy is to consider waves in the sea. They readily wrap round small rocks but are reflected from cliffs. So it is with a loudspeaker driver. The lower the frequency the more the sound will wrap around the driver. A driver suspended freely in air will have no bass. We need a mechanism for blocking this interaction and the cabinet serves to do this.

There are two common ways of reducing panel output:

- Adding bracing between the panels to increase stiffness.
- Adding damping pads to the panels.

The idea behind method 1 is that the increased stiffness reduces panel motion. What it does in fact is to raise the frequency of any resonances. A similar effect would

occur if the panel thickness were to be increased. This might be of some benefit if the loudspeaker system has separate enclosures for different drivers, like in R Series. The resonances in any one enclosure may be pushed out of the working frequency range of the driver housed in it. However, there is a drawback to this method. The bass resonances may be pushed into the midrange, where the ear is more sensitive.

The addition of damping pads to the panels does work and was used on the R Series 2011. The pads are usually made of some bituminous material that converts deformation into heat and thus reduces the vibrational movement of the base panel. Unfortunately, most commercially available pads are designed to damp resonances in the thin metal panels used on cars. Their efficacy depends on matching the mechanical impedances of panel and damping pad and the match between the pads and wood is not ideal.

KEF Engineers developed a technique, originally for the LS50 loudspeaker system but applied to all R Series 2018 systems, that combines the two approaches and is more effective than both. The technique, called damped bracing, consists of strategically placed wooden braces that, instead of being rigidly coupled to the panels are joined via a lossy interface. The braces are placed where the panel movement would otherwise be greatest and the lossy layer, like normal damping pads, converts the energy into heat.

Additional damped braces are situated at the back of each driver, which reduce the level of reactionary vibration transmitted from the driver to the cabinet.

The reduction in sound output from the cabinet varies model by model, depending on the exact geometry, but is typically of the order of 20dB, as shown in figure 3. Cabinet sound radiation is highly distorted and, at the resonance frequencies, causes time-smearing as the output hangs on. The increase in clarity wrought by the damped bracing is readily noticeable, is probably best in class for single-enclosure multi-way loudspeaker systems and is comparable to the best high-end systems.

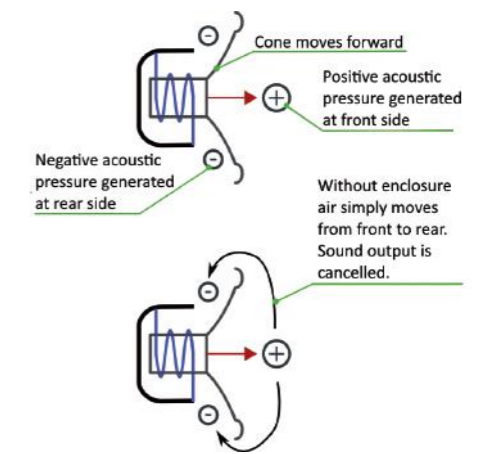

Figure 1
Driver in free air



Figure 2
R11 Cabinet construction

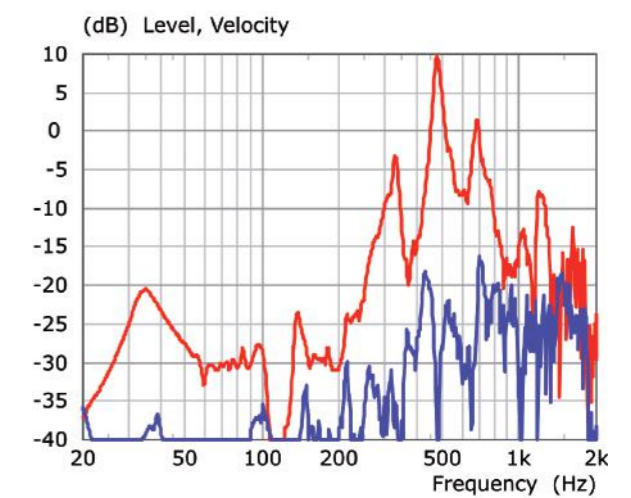

Figure 3
Panel vibration — without damping — with damped bracing

Directivity and diffraction

Both these attributes are affected by the geometry of the cabinet and so are lumped together here.

It is not often appreciated that the directivity of any loudspeaker system is controlled as much by the geometry of the cabinet as by the size of the drivers. In this, the engineer is helped by the fact that listeners may occupy positions that vary in the horizontal plane, but ear height differs little. It follows that it is much more important to keep the horizontal dispersion of the loudspeaker wide than is the vertical.

It was stated above that each of the R Series cabinets is slim. Not only does this minimise the cabinet's visual impact, but it allows the wide horizontal directivity required to create a stable sound stage for all listeners. The larger systems in the range employ multiple small-diameter drivers rather than a single larger diameter one precisely so the cabinet can remain slim and maintain the desired horizontal directivity. There is a small reduction in vertical directivity – but this is not a problem at bass frequencies, where the wavelength is long compared to the driver spacing. In the more critical midrange, the Uni-Q array gives far better vertical directivity than can be had from multiple vertically-displaced drivers.

Diffraction – the bending of wave motion around corners – can cause time smearing. Some of the sound energy generated by the drivers travels along the front surface or baffle of the cabinet and, if it reaches an edge, re-radiates as shown by figure 5. It's rather like having small secondary drivers spread along the edge of the cabinet. But this radiation is delayed compared to the sound coming directly from the driver, approximately by the time it takes to travel from the driver to the edge. There is thus a degree of time smearing that impairs the clarity of what the listener hears. Not only that, but there is perturbation of the frequency response because this secondary radiation goes in and out of phase with the direct sound as the frequency and commensurate wavelength vary.

The classic way of dealing with this effect is to round the sharp corners of the cabinet. In simple terms, this can be regarded as creating a multitude of edges, each with much lower levels of secondary radiation. The total level is much lower with the result that the time smearing becomes

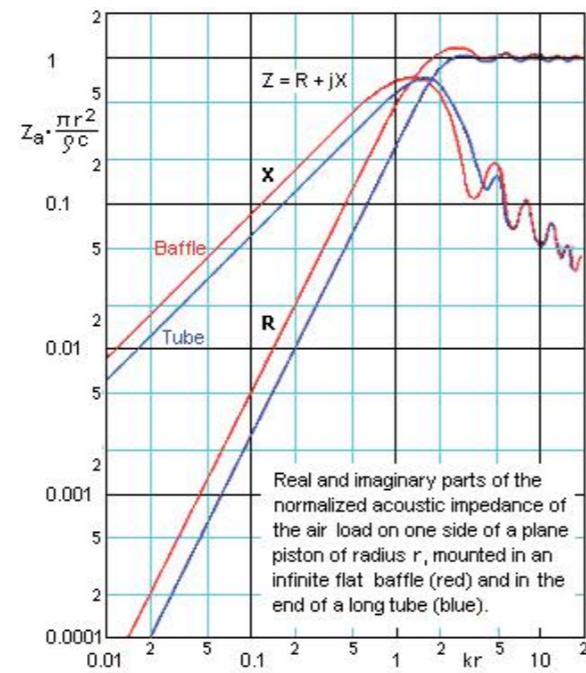

Figure 4
Acoustic Impedances after Beranek - Note that it is the 20dB/decade slope of the real part that affects the driver response in its working range

inaudible and the driver's response smoother. However, the radius of curvature must be of the same order as the wavelength of the sound, the overall width of the cabinet increases, making it more visually intrusive, and the cost of manufacture increases considerably. So, whilst this technique is often found on the most expensive systems, it is not appropriate to the R Series.

With most manufacturers, the diffraction effect is something to be suffered and not talked about. But the fact that we are talking about it here indicates that KEF engineers have successfully tackled the problem by a bit of lateral thinking made possible by the fact that Uni-Q drivers are used throughout.

It has been known for many years, and is illustrated by Leo Beranek in his book "Acoustics", published in 1954, that the acoustic impedance of a driver (the interface between the diaphragm motion and radiated sound) is smooth when mounted both in an infinite baffle (as expected) and at the end of a long tube the same diameter as the diaphragm. This latter situation comes about because the dispersion of the driver is such that it doesn't acoustically "see" the edges of the tube. The physics of this situation can be bent a little and it can be shown that a driver mounted in a cabinet not much wider than itself has a very low level of diffraction. It's not perfect, but the level of diffraction is much lower than it would otherwise be.

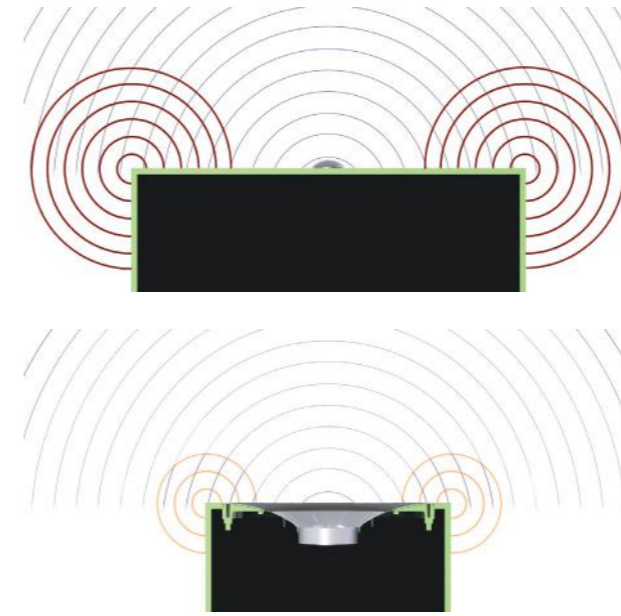

Figure 5
Simulation of tweeter output
top – tweeter mounted directly in baffle
bottom – tweeter in Uni-Q array with shadow flare— direct — diffracted

If we look at the drivers used in the R Series systems, we can see that the bass drivers follow this requirement, but the midrange and tweeter drivers do not. Normally, the tweeter would be the most to suffer because it is much smaller than the width of the cabinet, which is determined by the diameter of the bass drivers. However, in the Uni-Q driver (more of which later), the tweeter fires into an acoustic waveguide formed by the midrange diaphragm and it is the diameter of this relative to the width of the cabinet that determines the level of diffraction.

There is more work to be done, because the diameter of the midrange (for other reasons) is smaller than that of the bass drivers, and it is here that the lateral thinking comes into play.

Around the Uni-Q driver array is what is normally called a trim ring. Not simply a decorative piece, the R Series trim ring is specially shaped and engineered. It increases the effective diameter of the waveguide such that the driver array "sees" the edges of the cabinet much less than if it were mounted normally. Hence the name "Shadow Flare". The level of secondary radiation is decreased, resulting in less time-smearing, greater clarity and a smoother response.

This technique was originally developed for the Reference Series products and illustrates our trickle-down philosophy.

Ports

Ports are used to augment bass response. They have the dual advantage that they enable a lower cut-off frequency than closed-box systems for the same size of enclosure and, within the operating range of the port, the bass driver moves less, thus lowering distortion.

Ports are not without their drawbacks, however.

- They can be a window to resonances in the air cavity inside the cabinet.
- At midrange frequencies, they act rather like an organ pipe and exhibit a series of resonances.
- They can be a source of noise if turbulence is allowed to happen as air vents out at each end of the port (so-called chuffing).

KEF engineers have tackled each of these potential problems.

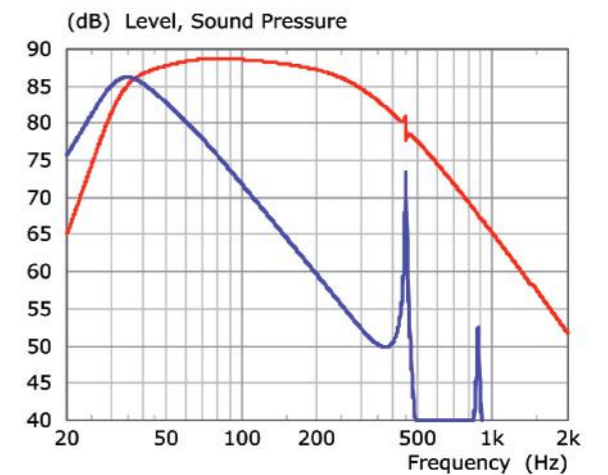

Figure 6
Simulation of bass driver + port — and port only —when the port is placed close to the node of internal resonances.

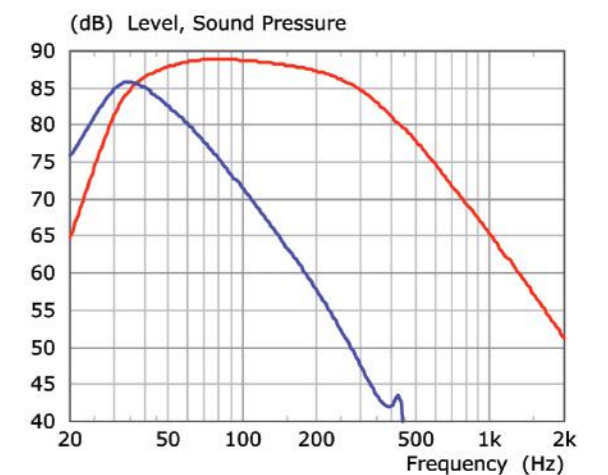

Figure 7
Simulation of bass driver + port — and port only —when the port is placed close to the antinode of internal resonances.



Figure 8
Pressure of the first "organ pipe" resonance in a port Top – rigid walls and no end flare Bottom – flexible walls and end flares

Organ pipe resonances

These resonances within the port itself can be drastically reduced if the walls of the port have a degree of flexibility. Instead of the normal rigid plastic, the walls are fabricated from closed-cell foam. Originally developed for the LS50 loudspeaker, this technique dramatically reduces the pressure variations inherent in these higher frequency resonances and renders them less audible. Figure 8 illustrates this technique using Finite Element Analysis (FEA), where the colour scale from green through to red indicates the level of air pressure.

Turbulence

This occurs at both ends of the port as the air exits the port either to the open air or the air enclosed within the cabinet. The solution is to flare both ends of the port. The progressive expansion of the air afforded by the flaring reduces turbulence and thus audible chuffing. It should be noted that, if turbulence is allowed to develop, not only is it audible, but the performance of the port changes with sound level, impairing the dynamic range of the loudspeaker.

Resonances inside the cabinet

The port(s) are positioned on the rear panel of the cabinet. This has two advantages:

- Resonances inside the cabinet are at relatively high frequencies and the sounds are not directed towards the listener.
- There is more freedom on the rear panel compared to the front in positioning the port so it is placed close to antinodes (nulls) of the resonances, so less energy is transmitted through the port.

To illustrate this last point, figures 6 & 7 show the difference in output when the port is placed at a node and an antinode of an internal resonance. For the first of these measurements there is no wadding inside the cabinet, so the effect is made clearer. The resonance can clearly be seen in the total response.

When the ports are optimally placed and the wadding added, the resonances are greatly depressed and cannot be detected in the overall response.

Drive units (Drivers)

All but one of the systems are 3-way – they have one or more bass drivers, a midrange driver and a tweeter. The midrange driver and tweeter are combined into a single array known as Uni-Q. The only 2-way in the series utilises a bass-midrange driver instead of a dedicated midrange driver in its Uni-Q array.

Bass drivers

Whether the system contains one, two or four bass drivers, the design remains the same, save for the impedance of each individual driver. The number of bass drivers simply determines the maximum loudness of the system for a given level of distortion. Note that, when there is an even number of bass drivers, these are symmetrically arranged above and below the Uni-Q array to preserve a virtual point source over the full range.

Diaphragm

This is a 2-part structure, comprising a shallow concave aluminium front skin connected to the driving voice coil by a more conventional paper cone (see figure 9).

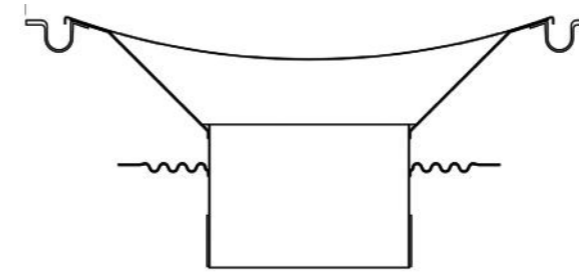

Figure 9
Cross-section of bass driver moving parts

The aluminium skin has a shallow profile to minimise perturbation of the response of adjacent drivers as a result of diffraction.

The cone itself is vented to allow free movement of air as the diaphragm assembly moves back and forth. The static centre pole of the magnet structure causes the volume of air between the paper cone and the front aluminium skin to vary with diaphragm position and this must not become trapped, otherwise the air will be pumped through the narrow apertures of the magnet system and cause noise.

The front aluminium skin provides the stiffness necessary to provide pistonic radiation and therefore temporal accuracy within the working range of the driver. However, like all stiff materials, the stiffness is not infinite and at some frequency diaphragm breakup sets in and the Q (sharpness) of the resonances is high – the response peaks at resonance can be as much as 20dB above the pistonic response. Such resonances are not readily suppressed by the relatively gradual attenuation of the crossover network and, if left unchecked, will cause colouration.

To reduce the intrusion of these higher-frequency resonances, the paper cone is joined to the aluminium skin at a nodal ring, not at the periphery. The nodal ring is an antinode of the lowest resonance and, when driven there, the resonance

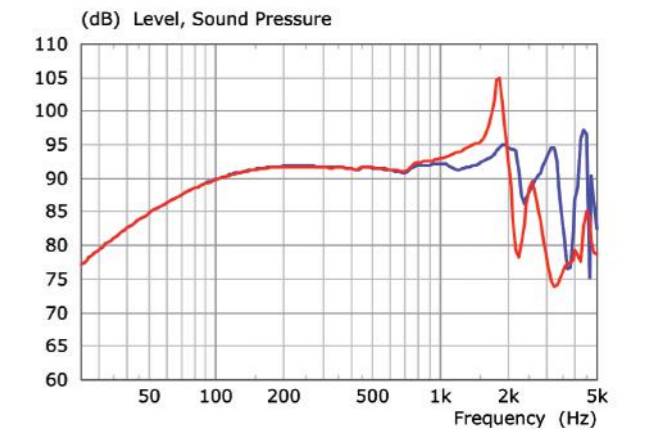

Figure 10
— Response of non-optimised bass driver — Response of optimised bass driver Panel

is not excited.

Magnet system

With the new series, the magnet system has been totally redesigned. One of the key objectives is to keep the magnetic flux density seen by the voice coil as constant as possible with coil position.

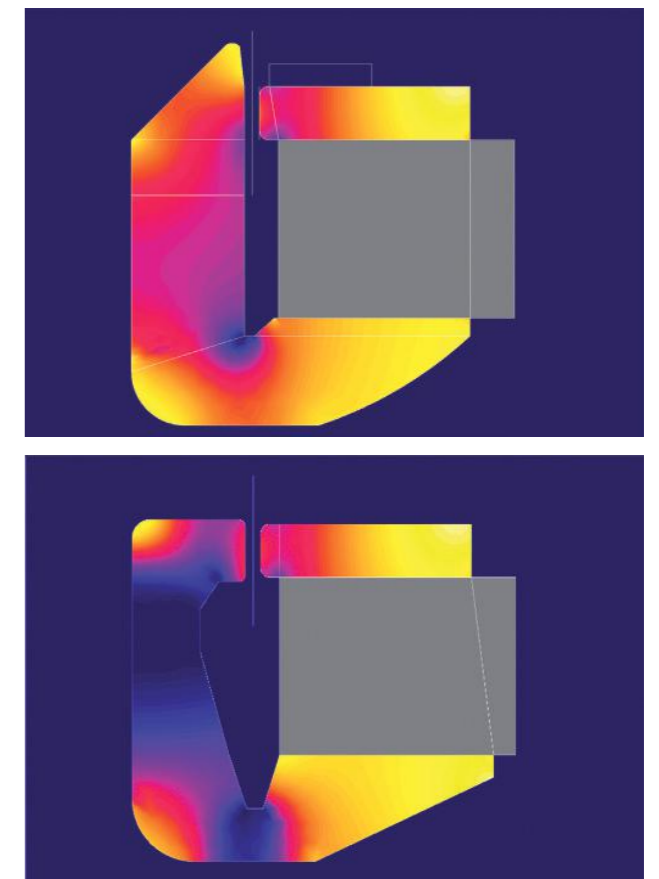

Figure 11
Finite Element Analysis (FEA) of
Top – 2011 R Series bass driver magnet system
Bottom – 2018 R Series bass driver magnet system

To this end, the old magnet system featured an extended centre pole that balanced the solid material that connected to the back plate. However, this design is still somewhat asymmetric, with the result that the force on the voice coil was also asymmetric, introducing more distortion than is necessary. Further, the asymmetric nature of the metalwork caused the coil's inductance to vary with position, altering the termination, and therefore the equalisation, of the crossover. The new design is more complex and features a so-called T-shape pole (see figure 11).

This is more symmetric than the older design and, with the bulk of the centre pole being further from the voice coil, lowers both the coil's absolute inductance and its variation with position. The result is a useful reduction in even-order harmonic distortion.

Note, too, the undercut in the back plate that allows greater coil movement before the coil hits the back plate.

Another feature of the new design can be deduced by looking at the magnetic permeability in the metalwork. The darker the colour, the lower the permeability and, where it is almost black, the metalwork is saturated. This has two advantages for the performance:

- The saturation limits the flux density in the coil gap and so this remains constant regardless of the inevitable production tolerances in magnet strength.
- Saturation further reduces the absolute level of inductance of the voice coil and, with it, further reduces the variation in flux density that would normally occur as the coil moves back and forth in the gap.

Spider (Damper)

The spider, or rear suspension, contributes to the linearity of coil movement in addition to the magnet system. In this case, as we're dealing with symmetry, it's the odd-order harmonics that are mostly affected. The new spider design allows greater linear movement and a commensurate reduction in distortion, clearly illustrated in figure 12.

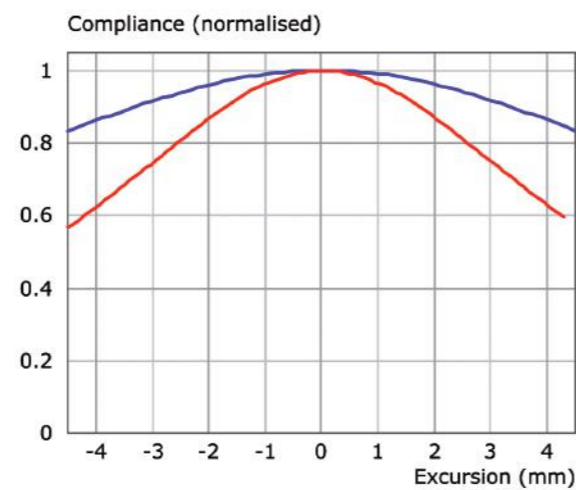

Figure 12
Suspension compliance as a function of diaphragm displacement
— Old spider — New spider

Uni-Q array

The Uni-Q array has been the mainstay of virtually all KEF loudspeakers since its introduction in 1988. It delivers the holy grail of loudspeaker design in that all sound appears to emanate from the same point in space. Coaxial loudspeakers had been around for many years before the introduction of Uni-Q, but the tweeter was never time aligned with the midrange or bass/midrange driver it was partnered with. Either the tweeter was in front of the larger driver, which brought the added disadvantage that the tweeter impaired the response of the driver it was in front of, or it was well behind. With Uni-Q, both drivers have their acoustic centre at the same point and the larger driver acts as a waveguide for the tweeter. The result is that the blend between the two units is virtually seamless in terms of both response and dispersion. The two units together can be regarded as a single driver without the performance shortfall that would be suffered by a true single driver covering such a wide frequency range.

Over the intervening years, the Uni-Q concept has been progressively refined. The midrange cone shape has been optimised to create just the right amount of dispersion at all frequencies and innovations such as the tangerine waveguide have improved the performance of the tweeter. This is the 12th generation of the array and brings an extra degree of refinement to the performance, but it is worthwhile to describe everything that goes into this remarkable array, not just the latest refinement.

One of the requirements of building this driver combination is the need to maintain tight tolerances. Some of the gaps between parts are necessarily small and without robotic assembly methods it would be impossible to achieve consistency of performance. There is a place for hand building, but this is not it.

Filling in the gaps

One of the problems with constructing a combination driver array like Uni-Q is dealing with the gaps that separate the constituent parts. There is a narrow channel – an annular gap – between the moving midrange voice coil and the static start of the tweeter waveguide. This channel acts as an organ-pipe-like resonator, and is excited by the tweeter output. The resonances modify the response of the tweeter, adding a series of glitches that are not present if the gap is closed off – simulating a perfectly smooth waveguide.

Obviously, this annular gap is necessary to allow the midrange cone and voice coil to move, so the solution was to create a cavity between the midrange and tweeter magnets to which this annular gap connected. Adding damping to this newly-created cavity was found to be effective in taming the resonances in the annular gap and the removal of the response glitches was immediately apparent as an improvement in detail clarity.

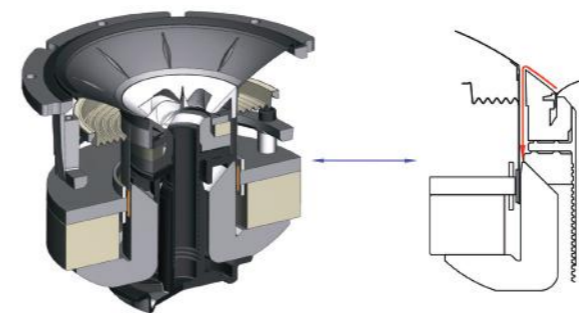

Figure 13
Uni-Q array with no gap between HF and MF magnets

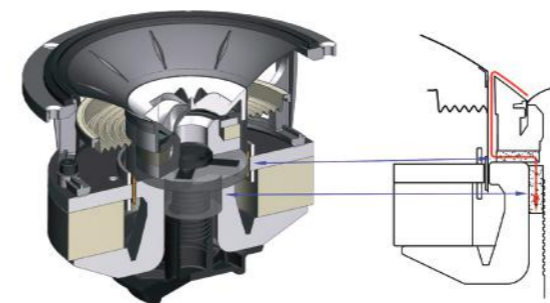

Figure 14
Uni-Q array with opened cavity between HF and MF magnets and damping added

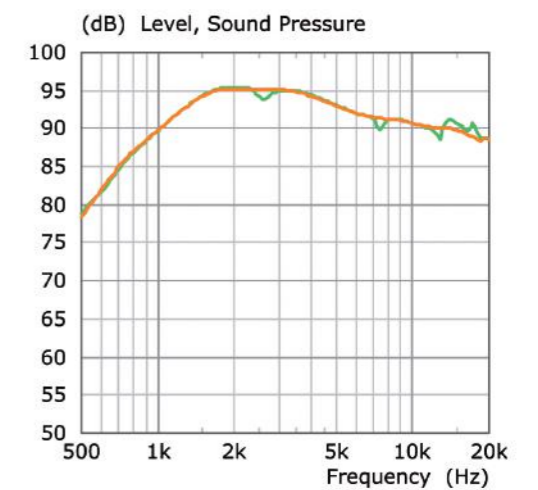

Figure 15
Simulation of tweeter response
— In perfect waveguide — With open gap

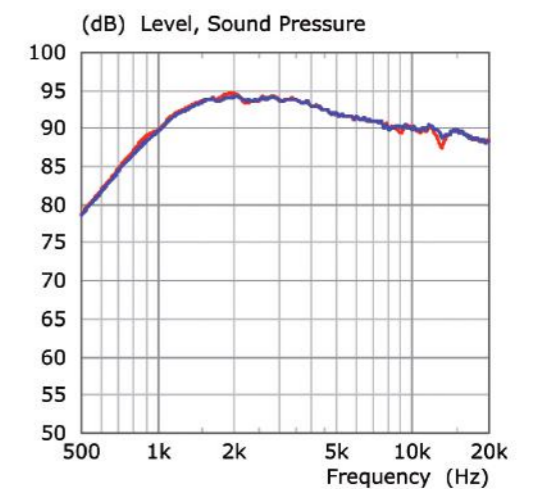

Figure 16
Actual tweeter response
— Original — With cavity damping

Midrange

Cone and surround

The cone is formed from a magnesium/aluminium alloy. Like the front skin of the bass driver, it serves to provide the necessary stiffness to give pure piston motion over the driver's working range. The stiffness is increased by the radial embossing in the cone profile, but nevertheless it is prone to high-Q breakup in the frequency range covered by the tweeter.



Figure 17
Uni-Q drive exploded view

The KEF Blade uses nodal drive (as described on page 11, where the technique is used on the bass drivers) to tame these resonances. But that technique, when applied to a Uni-Q array, cannot use an intermediate cone and instead requires an expensive large diameter voice coil which was not appropriate to the R Series.

Instead, there is a lossy interface where the voice coil joins the cone. This interface serves to decouple the drive at high frequencies. The high-Q resonances are tamed to the extent that they may be properly attenuated by the crossover and not break through the tweeter output.

Figure 19 illustrates the improvement in the unit's response as a result of using the lossy interface.

The surround is particularly problematic. It has to allow the cone to move freely, but it is also a critical part of the tweeter waveguide. Surrounds also tend to break into complex vibrational behaviour at higher frequencies, often moving in the opposite direction to the cone. The so-called "surround dip" in a driver's response is quite common. The new R Series driver features an improved surround geometry, achieved through extensive computer simulation, optimisation and practical experimentation. It allows greater movement of the cone and gives a smoother response for both midrange and tweeter.



Figure 18
lossy interface between voice coil and midrange cone

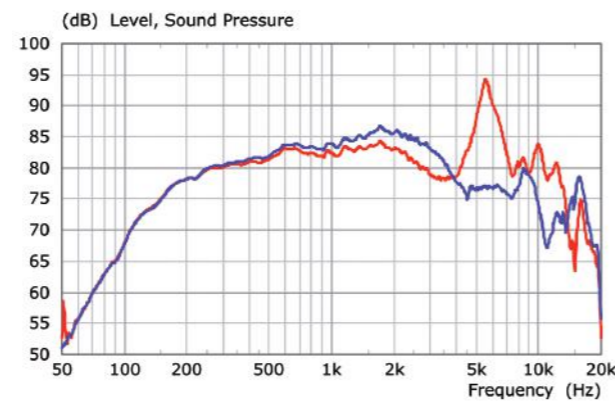

Figure 19
Response of midrange driver measured without crossover in 2π baffle
— without interface — with interface

Magnet system

The design of the magnet system follows that of the bass drivers, alongside the addition of aluminium de-modulation rings. The reduction in harmonic distortion as a result of the new magnet system and improved surround geometry is shown in figure 20.

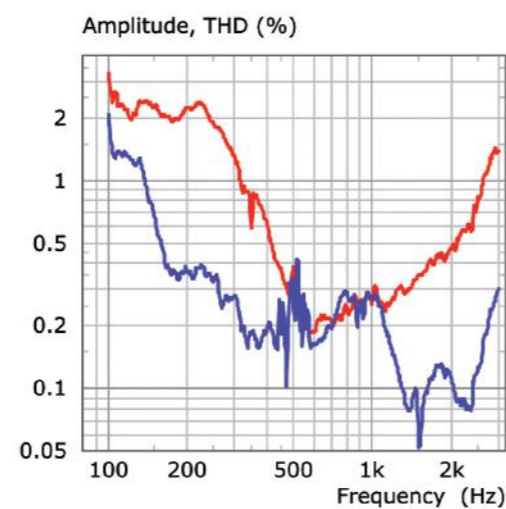

Figure 20
Midrange driver distortion (1m, 5.6V RMS)
— 2011 R Series — 2018 R Series

Tweeter

Diaphragm assembly

The dome diaphragm itself is aluminium. More exotic materials – diamond and beryllium for example – are sometimes used in an effort to increase stiffness and push the piston region of the tweeter to the limits of human hearing. But this can be done with aluminium at far lower cost, providing some ingenuity is used in designing how the dome is constructed.

The optimum dome shape for waveguide loading is a spherical cross-section, but the optimal shape for stiffness is an elliptical cross-section. Both were combined into the patented KEF Stiffened Dome. An elliptical dome attaches to the voice coil former and the centre is removed. This is capped by a spherical dome and a very stiff triangular section is formed where the two parts join.

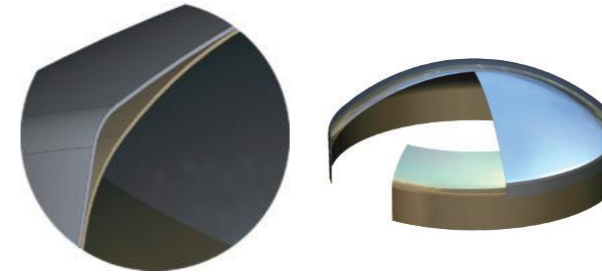

Figure 21
3D CAD sectional views of the tweeter dome and extended former that meet to form a triangular stiffening member at the dome edge.

Tangerine waveguide



Figure 22 Tangerine waveguide

The interface between the radiating dome of the tweeter and the waveguide formed by the midrange dome is extremely critical. Ideally, the diaphragm should be a pulsating dome, which would involve the radius of curvature changing. This is not possible and the motion is in the same direction all over the surface of the dome. To compensate for this non-ideal situation and taking a leaf out of the design of pressure drivers, the Tangerine Waveguide was developed to restore correct coupling between the dome and the whole waveguide.

The improved coupling at high frequencies above 5kHz brings with it a useful increase in sensitivity and a reduction in the height of the first resonance peak, illustrated by figure 23.

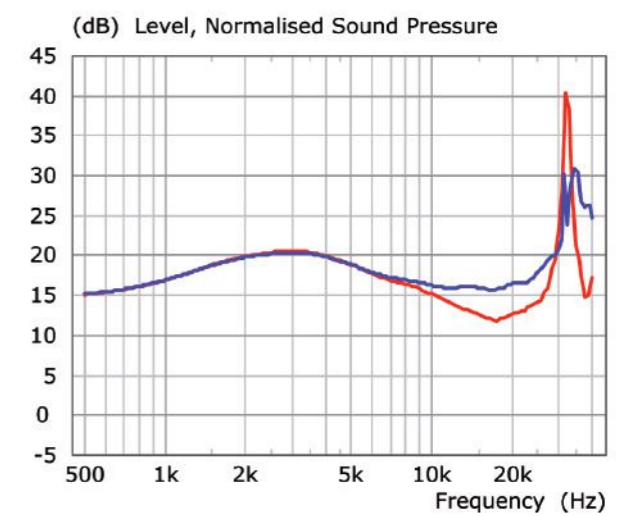

Figure 23
Simulated response of tweeter
— without tangerine waveguide — with tangerine waveguide

Rear loading

Like any drive unit, the tweeter radiates as much energy backwards as it does forwards. Not only does this energy have to be absorbed, but there must be sufficient volume behind the dome to prevent a build-up of excessive pressure. This pressure can impair the suspension of the dome and cause displacement of the ferrofluid that sits in the magnet gap to cool the voice coil.

To that end, the dome vents through the centre pole of the magnet system to a cavity filled with absorbent wadding. The cavity is tapered to that, when the wadding is inserted, it becomes more dense towards the rear of the cavity, gradually increasing absorption.

All the rearward energy is absorbed and cannot re-radiate through the dome after being reflected at the back of the cavity.

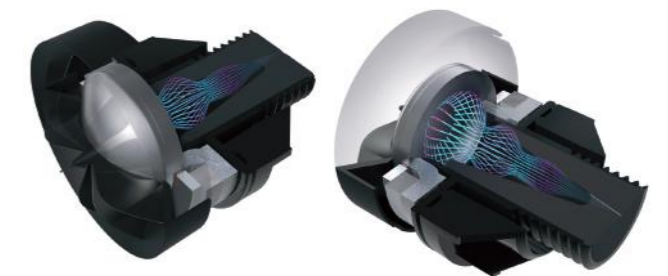

Figure 24
Front and rear view cross sections of tweeter showing rear loading

Crossovers

All 3-way crossovers, which covers all bar the 2-way Atmos® enabled R8a, follow the same general format shown in figure 25.

Each system in the range has been carefully voiced using a wide variety of musical genres to ensure that no artificial enhancement is introduced.

All crossovers have a reduced component count. This has been made possible due to the decoupler in the Uni-Q midrange as well as the improved tweeter, both of which have inherently smoother responses and require less correction from the crossover. The series resistors in the MF and HF sections are merely to change the output level of these drivers to match that of the bass drivers.

The HF section features a tuned circuit (L1/C2) in parallel with the driver. This tuned to the fundamental resonance frequency of the driver and allows the series capacitor to have the correct attenuation. Without it, there would be excessive movement of the diaphragm and an unwanted hump in the response.

There are two tuned circuits in the LF section. One (L6/C6/R4) is tuned to the upper peak of the reflex impedance, and prevents the system impedance falling too low should the 2nd-order low-pass formed by L4 and C5 be allowed to interact with it. The inductor L5 is small and tunes with C5 to attenuate a residual high Q resonance in the driver response to prevent it colouring the overall sound.

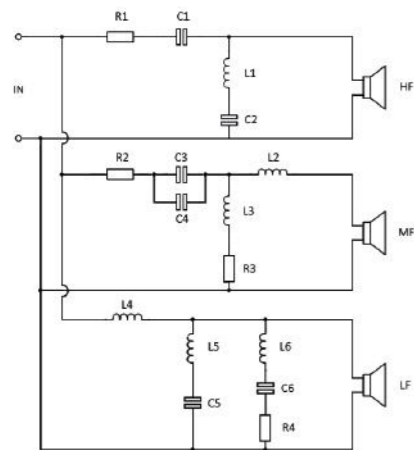

Figure 25
General schematic of R Series 3-way crossovers

All cored inductors in the new series crossovers use a laminated core material that substantially lowers distortion compared to the outgoing series, as shown in figure 27.

Mention should be made regarding the two parallel capacitors C3 and C4. The total value is large and low-loss types would be prohibitively expensive, so the bulk of the value is made up of an electrolytic type and around 10% of the total value is a polypropylene type, wired in parallel - the so-called bypass configuration.

This configuration delivers almost the same low loss and quality that would be achieved by having the full value solely supplied by one or more polypropylene capacitors wired in parallel, but at a much lower cost.

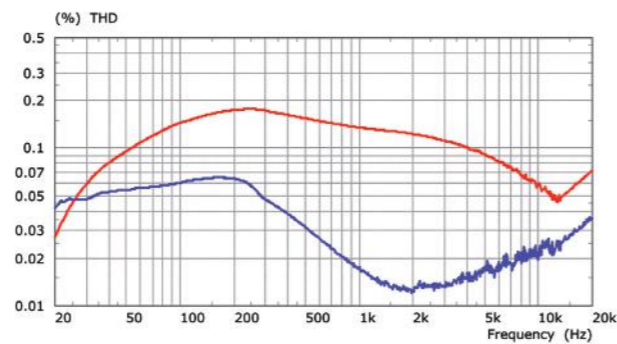

Figure 26
Inductor distortion at 100W
— 2011 R Series — 2018 R Series



Model Range

R3

Description

This is the smallest of the 'regular' loudspeakers in the range, being a compact 3-way stand-mount model. It is suited to the smaller room or closer listening, where less power is required to reach realistic sound levels.

Technical Specifications

Design	Three-way bass reflex
Drive units	Uni-Q Driver Array: HF: 25mm (1in.) vented aluminium dome MF: 125mm (5in.) aluminium cone Bass Driver: LF: 165mm (6.5in.) hybrid aluminium
Crossover frequency	400Hz, 2.9kHz
Frequency range (-6dB)	38Hz - 50kHz
Typical in-room bass response (-6dB)	30Hz
Frequency response (± 3 dB)	52Hz - 28kHz
Harmonic distortion	<0.3% 130Hz - 20kHz
Maximum output	110dB
Amplifier power (recommended)	15 - 180W
Nominal impedance	8 Ω (min.3.2 Ω)
Sensitivity (2.83V/1m)	87dB
Weight*	13.5 kg (29.8 lbs.)
Dimension (H x W x D) with terminal*	422.2 x 199.6 x 335.5 mm (16.6 x 7.9 x 13.2 in.)
Finishes	Black Gloss / White Gloss / Walnut

* Measurement per unit

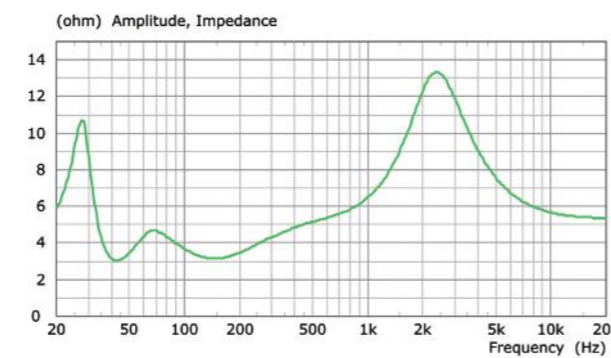
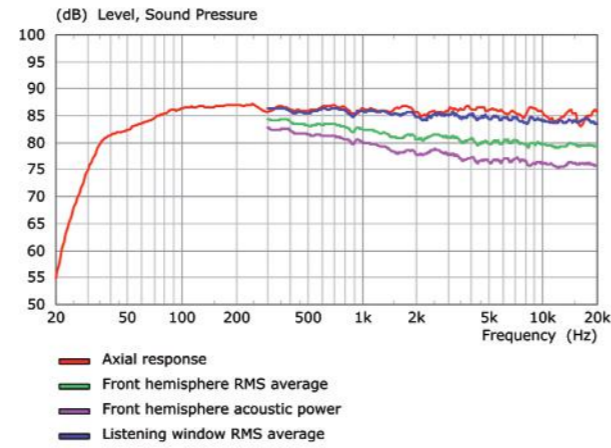

R5

Description

This is the smallest of the three floor-standers in the range. It's twin 130mm diameter bass drivers are positioned each side of the Uni-Q array in d'Appolito configuration, to preserve an effective point source delivery throughout the whole frequency range.

Technical Specifications

Design	Three-way bass reflex
Drive units	Uni-Q Driver Array: HF: 25mm (1in.) vented aluminium dome MF: 125mm (5in.) aluminium cone Bass Driver: LF: 2 x 130mm (5.25in.) hybrid aluminium
Crossover frequency	400Hz, 2.9kHz
Frequency range (-6dB)	38Hz - 50kHz
Typical in-room bass response (-6dB)	29Hz
Frequency response (± 3 dB)	58Hz - 28kHz
Harmonic distortion	<0.3% 120Hz - 20kHz
Maximum output	110dB
Amplifier power (recommended)	15 - 200W
Nominal impedance	8 Ω (min.3.2 Ω)
Sensitivity (2.83V/1m)	87dB
Weight*	27.3 kg (60.2 lbs.)
Dimension (H x W x D) with terminal*	1025 x 175 x 343.5 mm (40.4 x 6.9 x 13.5 in.)
Dimension (H x W x D) with terminal with Plinth*	1071.4 x 271.6 x 343.5 mm (42.2 x 10.7 x 13.5 in.)
Finishes	Black Gloss / White Gloss / Walnut

* Measurement per unit

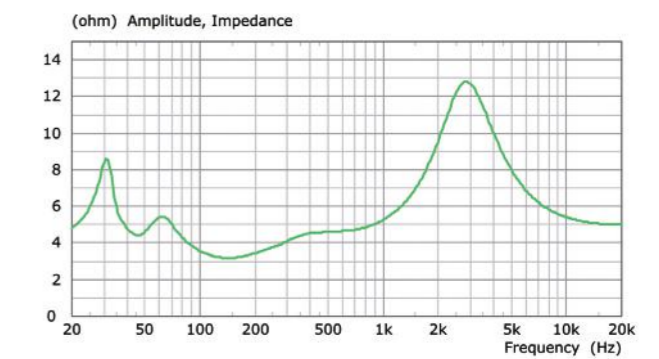
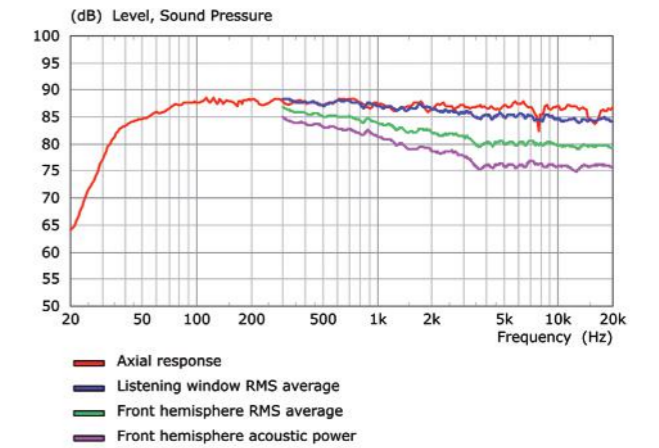

R7

Description

Like the R3, this is a floor-standing loudspeaker featuring twin bass drivers positioned above and below the Uni-Q array. However, the larger diameter of the bass drivers enables a higher sound level to be delivered and the larger cabinet affords a greater bass extension.

Technical Specifications

Design	Three-way bass reflex
Drive units	Uni-Q Driver Array: HF: 25mm (1in.) vented aluminium dome MF: 125mm (5in.) aluminium cone Bass Driver: LF: 2 x 165mm (6.5in.) hybrid aluminium
Crossover frequency	400Hz, 2.9kHz
Frequency range (-6dB)	33Hz - 50kHz
Typical in-room bass response (-6dB)	27Hz
Frequency response (±3dB)	48Hz - 28kHz
Harmonic distortion	<0.3% 100Hz - 20kHz
Maximum output	111dB
Amplifier power (recommended)	15 - 250W
Nominal impedance	8Ω (min.3.2Ω)
Sensitivity (2.83V/1m)	88dB
Weight*	31.4 kg (69.2 lbs.)
Dimension (H x W x D) with terminal*	1062 x 200 x 383.5 mm (41.8 x 7.9 x 15.1 in.)
Dimension (H x W x D) with terminal with Plinth*	1108.9 x 310.6 x 383.5 mm (43.7 x 12.2 x 15.1 in.)
Finishes	Black Gloss / White Gloss / Walnut

* Measurement per unit

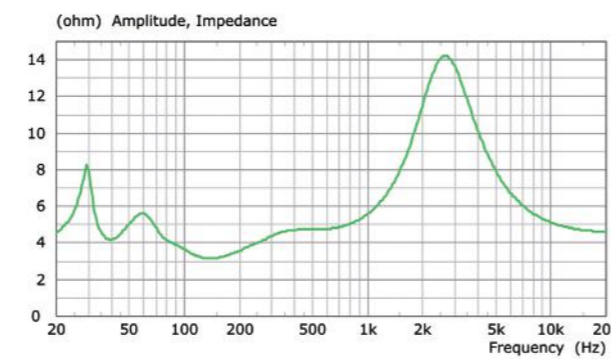
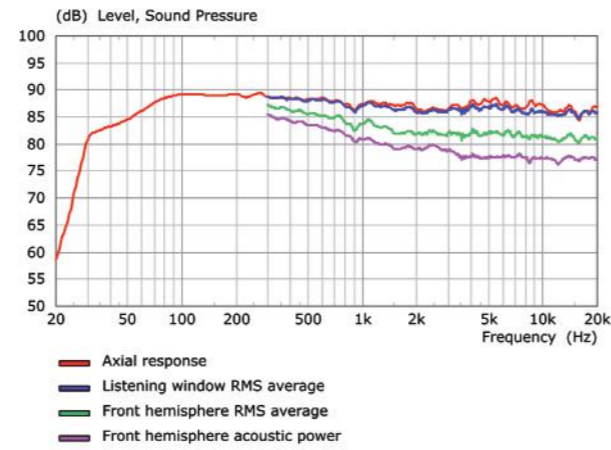

R11

Description

This, the largest loudspeaker in the range, features four 165mm (6½ inch) diameter bass drivers, enabling a enough sound level output to drive large rooms without distress. The large cabinet affords the most extended bass response.

Technical Specifications

Design	Three-way bass reflex
Drive units	Uni-Q Driver Array: HF: 25mm (1in.) vented aluminium dome MF: 125mm (5in.) aluminium cone Bass Driver: LF: 4 x 165mm (6.5in.) hybrid aluminium
Crossover frequency	400Hz, 2.9kHz
Frequency range (-6dB)	30Hz - 50kHz
Typical in-room bass response (-6dB)	26Hz
Frequency response (±3dB)	46Hz - 28kHz
Harmonic distortion	<0.3% 120Hz - 20kHz
Maximum output	113dB
Amplifier power (recommended)	15 - 300W
Nominal impedance	8Ω (min.3.2Ω)
Sensitivity (2.83V/1m)	90dB
Weight*	37.7 kg (83.1 lbs.)
Dimension (H x W x D) with terminal*	1249 x 200 x 383.5 mm (49.2 x 7.9 x 15.1 in.)
Dimension (H x W x D) with terminal with Plinth*	1295.5 x 310.6 x 383.5 mm (51 x 12.2 x 15.1 in.)
Finishes	Black Gloss / White Gloss / Walnut

* Measurement per unit

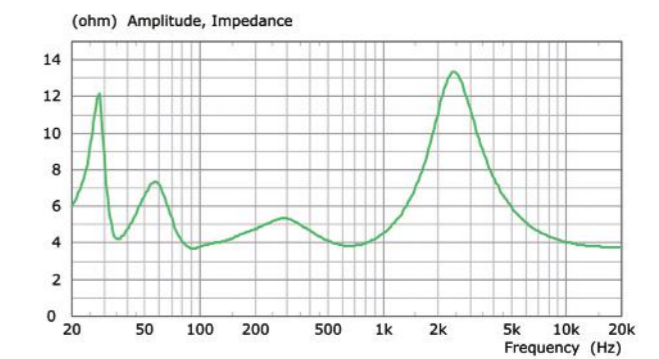
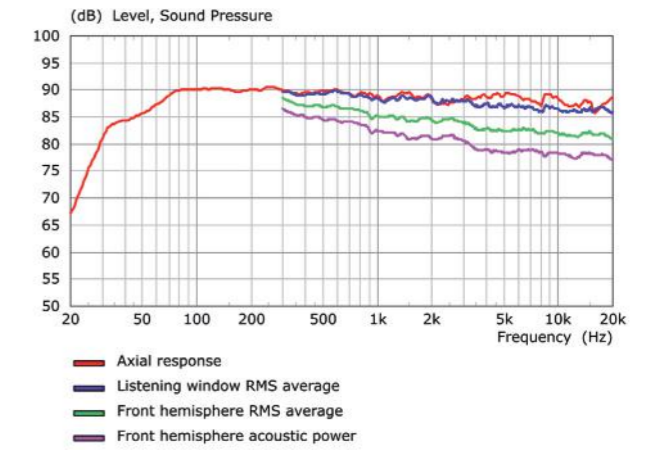

R2c

Description

This is the first of two special application loudspeakers. It's a dedicated centre-channel model and, like the R5 features two 130mm (5¼ inch) diameter bass drivers each side of a centrally placed Uni-Q array. Normally, the horizontally disposed drivers of centre-channel loudspeakers suffer a restricted horizontal dispersion in the crossover region between midrange and tweeter, or throughout the midrange band if two drivers are used to cover that frequency range. However, the point-source Uni-Q array avoids this and offers better horizontal dispersion than any other horizontally disposed configuration.

Technical Specifications

Design	Three-way closed box
Drive units	Uni-Q Driver Array: HF: 25mm (1in.) vented aluminium dome MF: 125mm (5in.) aluminium cone Bass Driver: LF: 2 x 130mm (5.25in.) hybrid aluminium
Crossover frequency	400Hz, 2.9kHz
Frequency range (-6dB)	64Hz - 50kHz
Typical in-room bass response (-6dB)	49Hz
Frequency response (±3dB)	74Hz - 28kHz
Harmonic distortion	<0.3% 120Hz - 20kHz
Maximum output	110dB
Amplifier power (recommended)	15 - 200W
Nominal impedance	8Ω (min.3.2Ω)
Sensitivity (2.83V/1m)	87dB
Weight*	16.9 kg (37.3 lbs.)
Dimension (H x W x D) with terminal*	175 x 550 x 308.5 mm (6.9 x 21.7 x 12.1 in.)
Finishes	Black Gloss / White Gloss / Walnut

* Measurement per unit

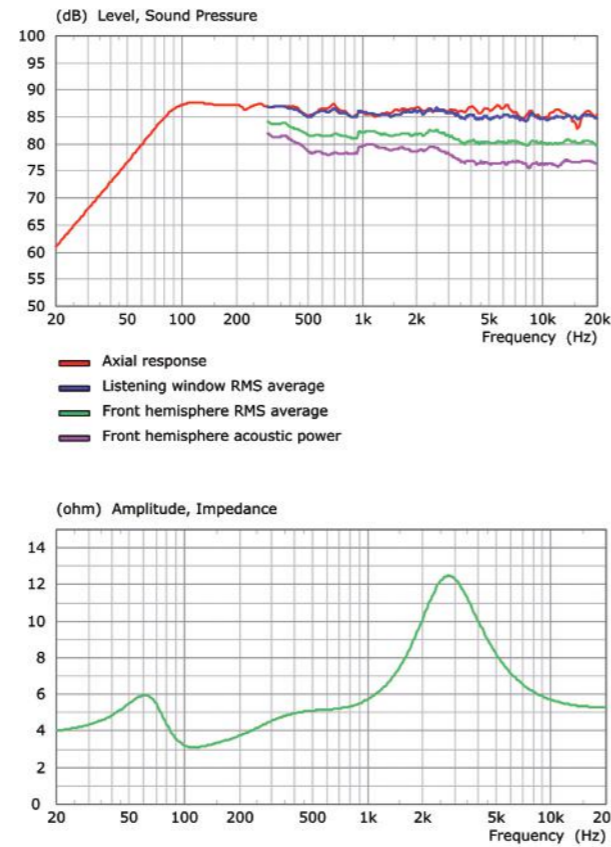

R8a

Description

This compact model is the only 2-way loudspeaker in the range. It features a single Uni-Q array, this time having a bass/midrange driver surrounding the centrally placed tweeter unit. Its angled front baffle makes it the perfect solution for either a wall-mounted surround loudspeaker or a speaker-top-mounted Dolby Atmos® module.

Technical Specifications

Design	Two-way closed Box
Drive units	Uni-Q Driver Array: HF: 25mm (1in.) vented aluminium dome MF/LF: 130mm (5.25in.) aluminium cone
Crossover frequency	2 kHz
Frequency range (-6dB)	96Hz - 19.5kHz
Typical in-room bass response (-6dB)	-
Frequency response (±3dB)	105Hz - 18.5kHz
Harmonic distortion	<0.3% 200Hz - 20kHz
Maximum output	106dB
Amplifier power (recommended)	25 - 150W
Nominal impedance	8Ω (min.4.2Ω)
Sensitivity (2.83V/1m)	86dB
Weight*	4.45 kg (9.8 lbs.)
Dimension (H x W x D) with terminal*	173.8 x 174.6 x 259 mm (6.8 x 6.9 x 10.2 in.)
Finishes	Black Gloss / White Gloss / Walnut

* Measurement per unit

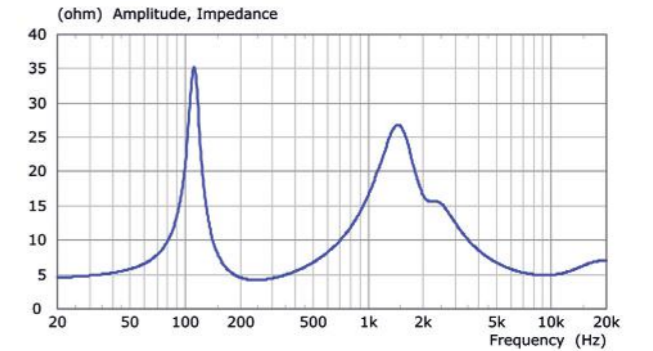

Summary

The R Series sits immediately below the Reference Series and borrows much of that range's technological attributes. It follows our belief that a great sounding loudspeaker is the result of solid, careful and effective engineering. This involves utilising every computer simulation and measuring technique available, backed up by practical experimentation and verification.

But loudspeakers, like any other component of the reproduction chain, are there to communicate more than mere measurements and specifications. As Raymond Cooke realised from the start, emotion and involvement are also part of what must be delivered to the listener. For that reason, engineers and non-engineers alike audition prototypes at every stage of development to make sure that the engineering is relevant and improves the overall performance.

More than that, it is the same team that guides every KEF product through its development, with the result that there is a consistency of what constitutes quality throughout the company's portfolio. The products deliver outstanding performance whatever the musical genre and regardless of whether the programme is 2-channel or multi-channel based.

The R Series incorporates many technologies that were pioneered by KEF - the Uni-Q point source array is probably the best-known and certainly one of the most effective of these. But this paper illustrates how every aspect of loudspeaker performance has been assessed and taken to the limit, within the imposed budgetary constraints, sometimes involving a new and different way of addressing the problem.

Some of the techniques described here are dealt with in greater detail in the KEF Reference Series white paper and the interested reader is urged to peruse that in addition to the other publications featured in the list of references on the next page.

Acknowledgements

The KEF logo and Uni-Q is are registered trademarks of GP Acoustics (UK) Ltd. Dolby and Atmos are trademarks of Dolby Laboratories.

References

O J Pedersen, S Bech and K Rasmussen, Final Report on Activities of Eureka Project ARCHIMEDES. Univ., 1995.

L R Fincham, A Jones and R H Small, "The Influence of Room Acoustics on Reproduced Sound, Part 2: Design of Wideband Coincident-Source Loudspeakers", in The 87th Convention of the AES, 1989.

"The Reference (white paper)", KEF R&D, May-2014.

K Kessler, D A Watson and M Cooke, "KEF 50 Years of Innovation in Sound" – A Limited Edition Book, GP Acoustics International Limited, Maidstone, UK, 2011.

M Dodd and J Oclec-Brown, "A New Methodology for the Acoustic Design of Compression Driver Phase Plugs with Radial Channels", presented at the Audio Engineering Society Convention 125, 2008.

M Dodd, "Optimum Diaphragm and Waveguide Geometry for Coincident source Drive Units", presented at the Audio Engineering Society Convention 121, 2006.

M Dodd and J Oclec-Brown, "Design of a Coincident Source Driver Array with a Radial Channel Phase-Plug and Novel Rigid Body Diaphragms", presented at the Audio Engineering Society Convention 127, 2009.

M Dodd, W Klippel, and J Oclec-Brown, "Voice Coil Impedance as a Function of Frequency and Displacement", presented at the Audio Engineering Society Convention 117, 2004.

L L Beranek, "Acoustics", McGraw-Hill, 1954 revised 1986

G Perkins, "Modelling loudspeaker cabinet diffraction", presented at the IOA Reproduced Sound conference, 2014.

M Dodd, "The Development of the KEF LS50, a Compact Two-way Loudspeaker System", presented at the Audio Engineering Society Conference: 51st International Conference: Loudspeakers and Headphones, 2013.